



## NOTICE DE MONTAGE KIT 3 POINTS

MODÈLE TRANSPORTER T5/T6

*Année : 2003 - À ce jour*



**ASSA ABLOY**

Une marque du Groupe ASSA ABLOY



- |                                     |                              |
|-------------------------------------|------------------------------|
| 1. Lime plate                       | 15. Clé à tube 10            |
| 2. Pince multiprise                 | 16. Clé à tube 8             |
| 3. Mètre ruban                      | 17. Clé plate 10             |
| 4. Cutter                           | 18. Marteau                  |
| 5. Stylo feutre                     | 19. Graisse                  |
| 6. Pince pour agrafe                | 20. Tournevis cruciforme     |
| 7. Foret scie cloche Ø24            | 21. Tournevis plat           |
| 8. Foret Ø13                        | 22. Jeu de clé torx          |
| 9. Foret Ø11                        | 23. Cisaille à mai           |
| 10. Foret Ø9                        | 24. Popeuse                  |
| 11. Foret Ø7                        | 25. Perceuse                 |
| 12. Foret Ø5                        | 26. Disqueuse                |
| 13. Foret étagé                     | 27. Antirouille (non fourni) |
| 14. Embout cruciforme pour visseuse |                              |

## Composition du Kit 3 points

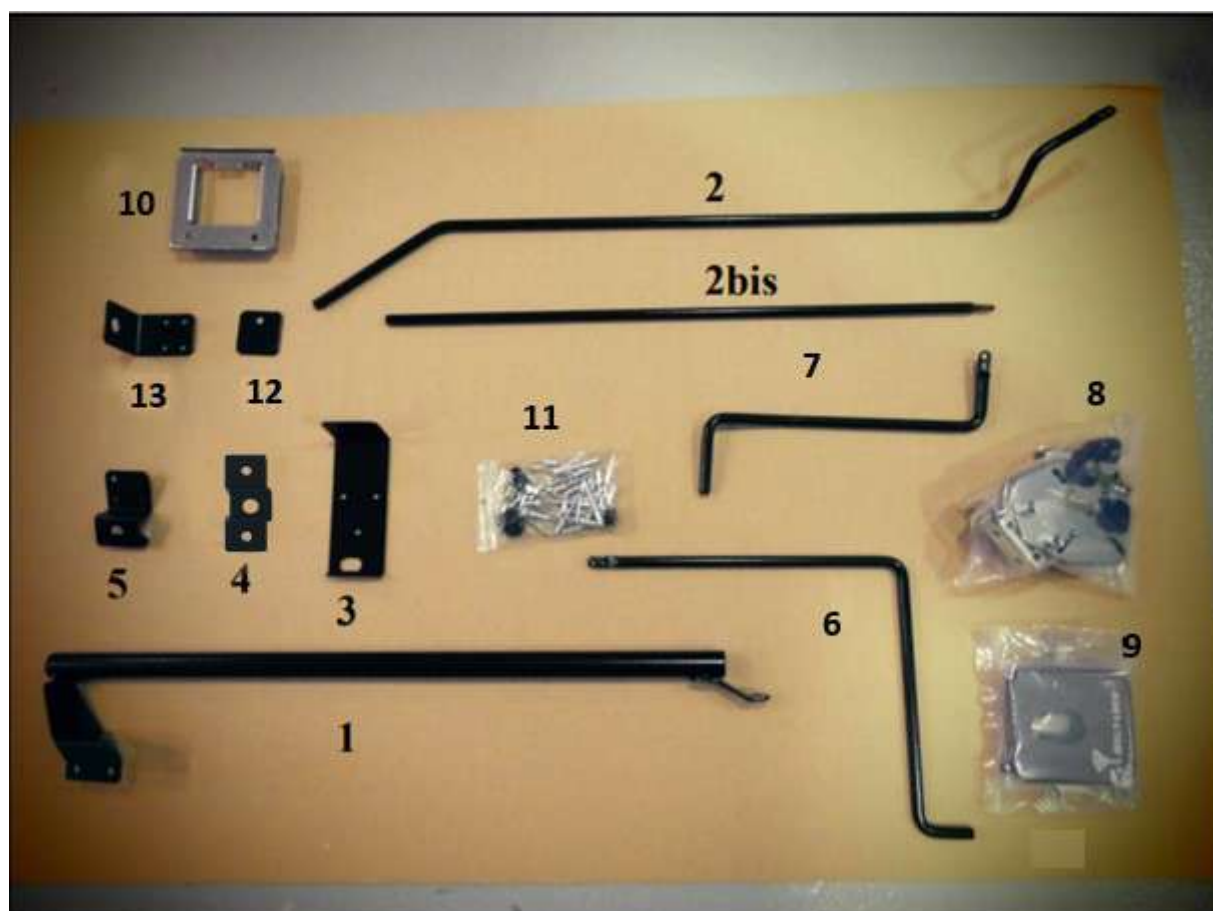

- |                         |                      |
|-------------------------|----------------------|
| 1. Guide tringle haute  | 8. Tringle basse     |
| 2. Tringle haute        | 9. Serrure           |
| 2bis. Tringle haute     | 10. Cache serrure    |
| 3. Gâche haute          | 11. Support serrure  |
| 4. Gâche latérale       | 12. Visserie         |
| 5. Gâche basse          | 13. Plaque de calage |
| 6. Gabarit de perçage** | 14. Equerre guide    |
| 7. Tringle latérale     |                      |

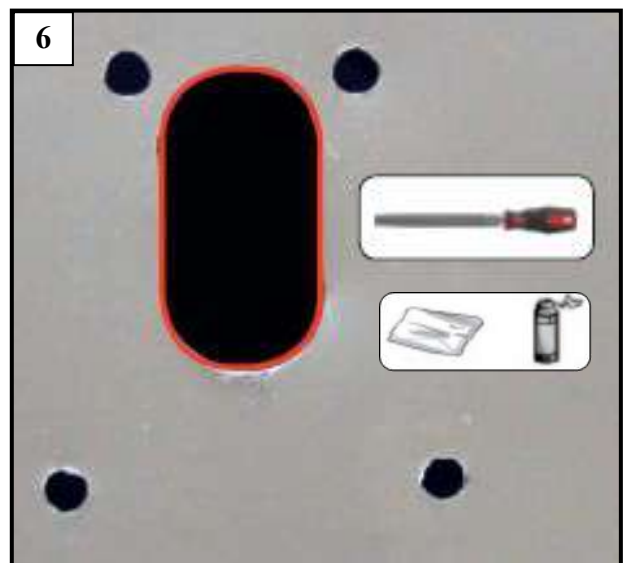
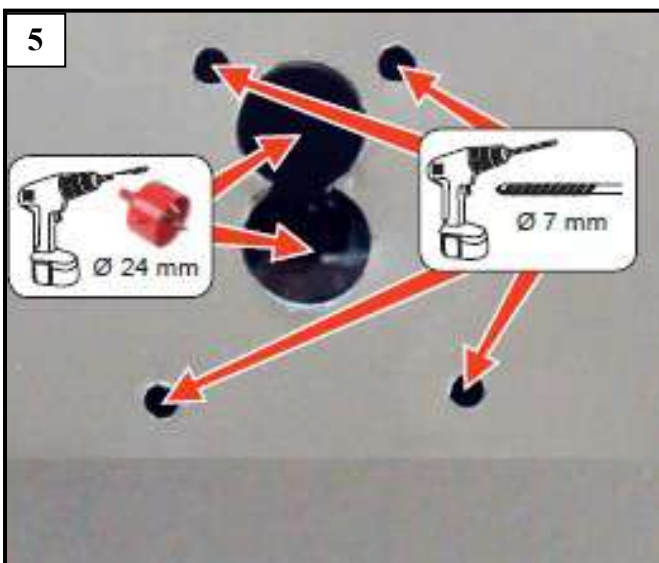
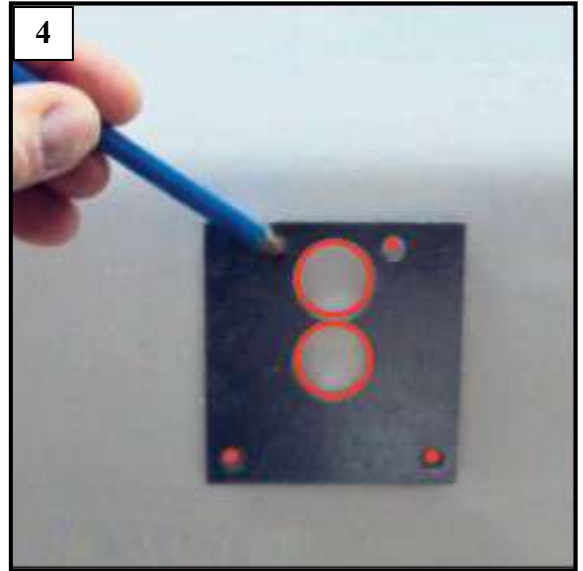
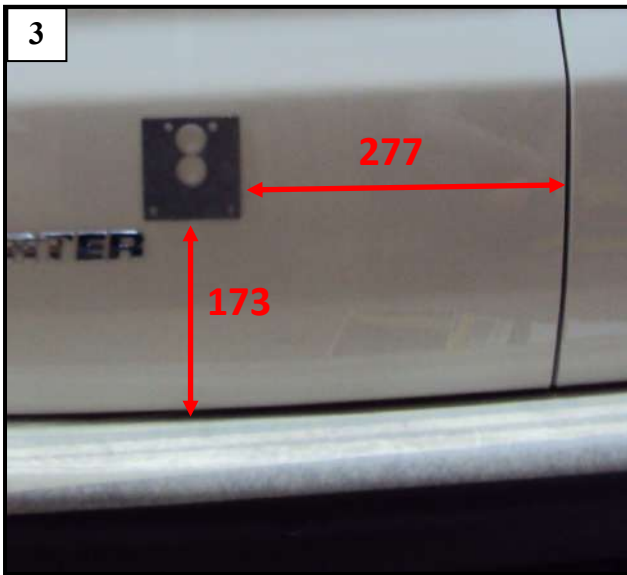
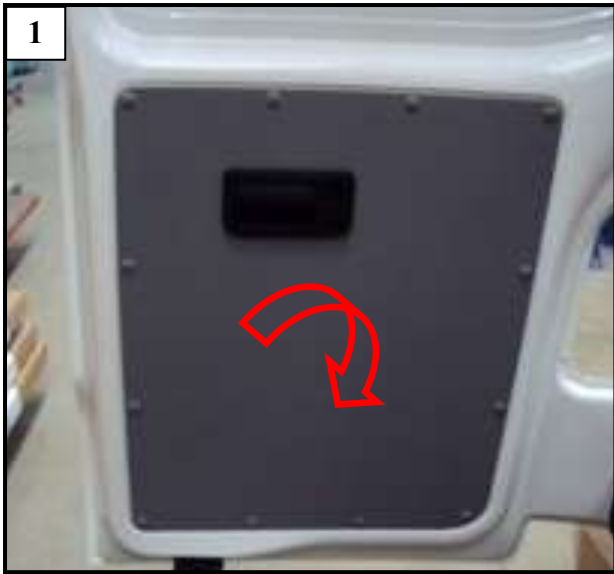



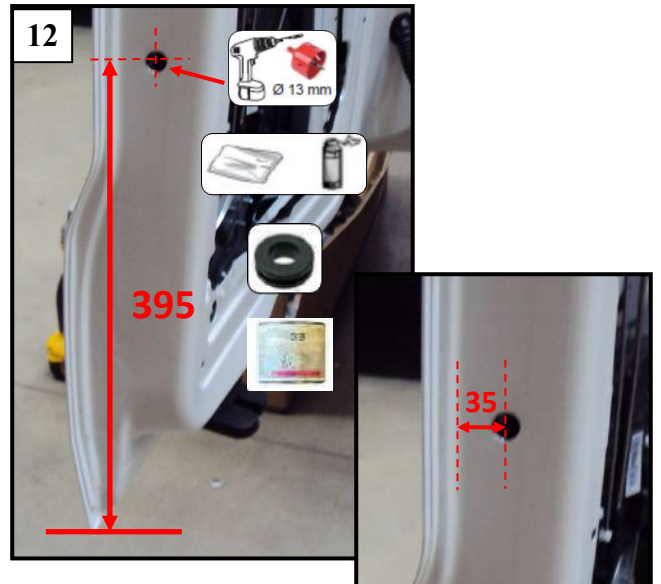
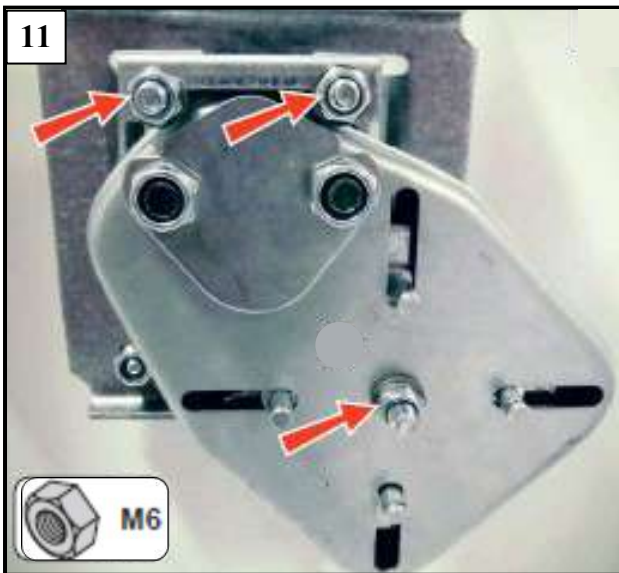
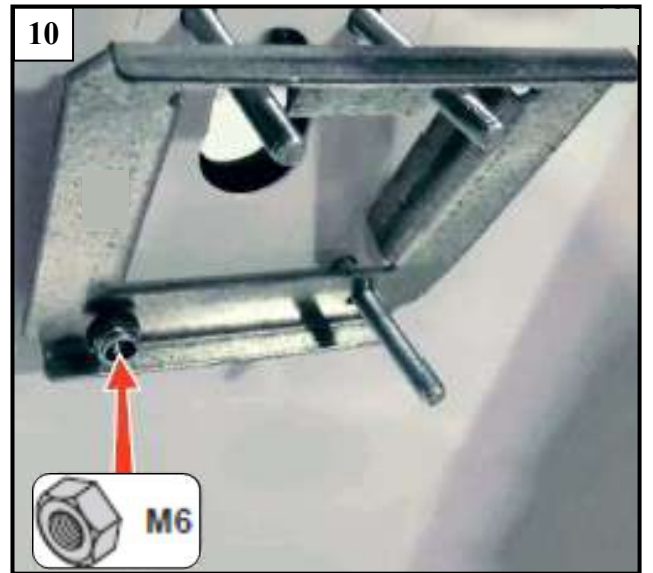
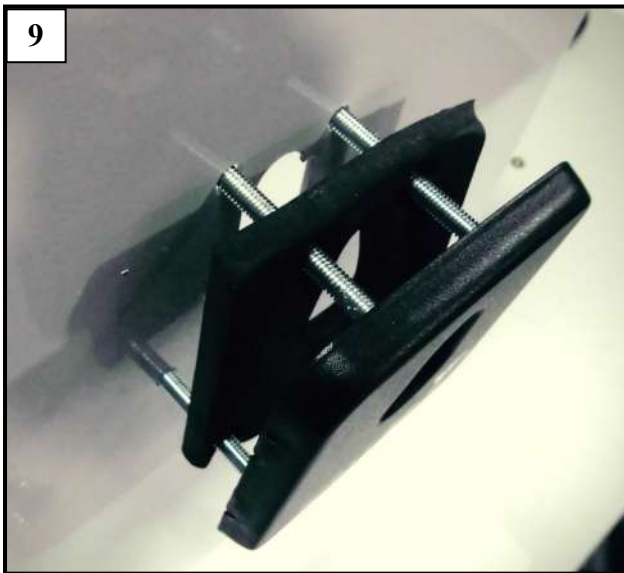
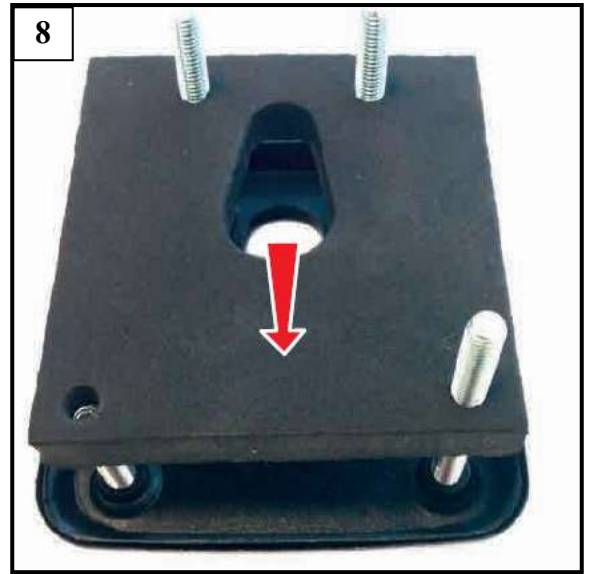
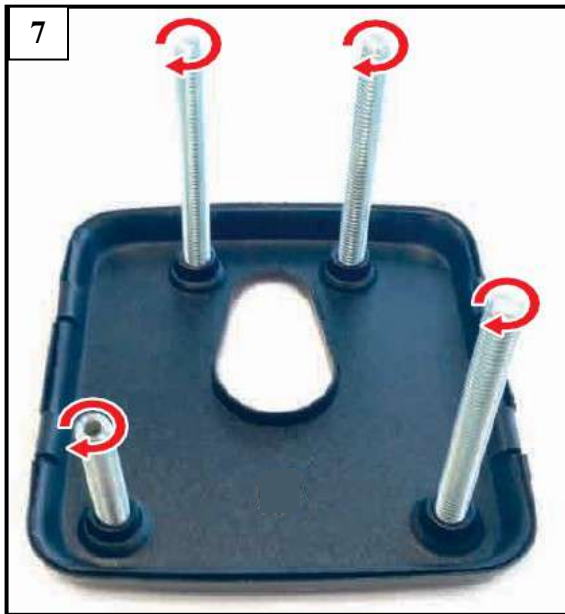

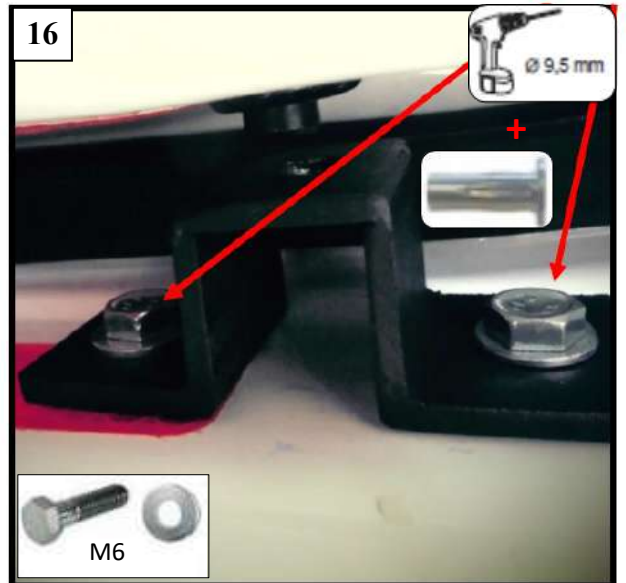
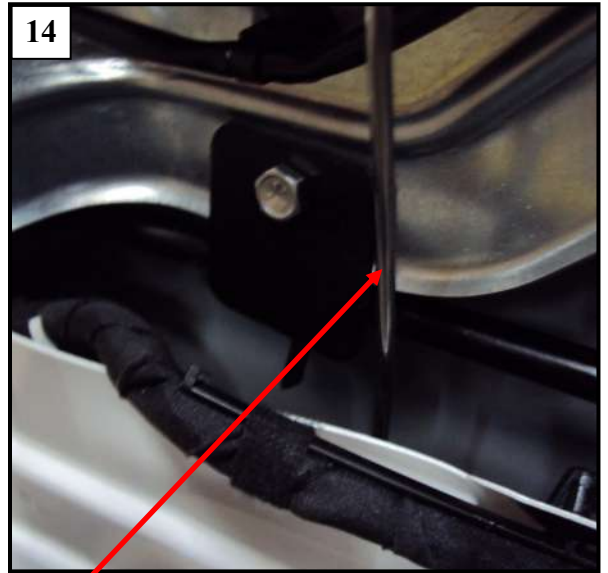
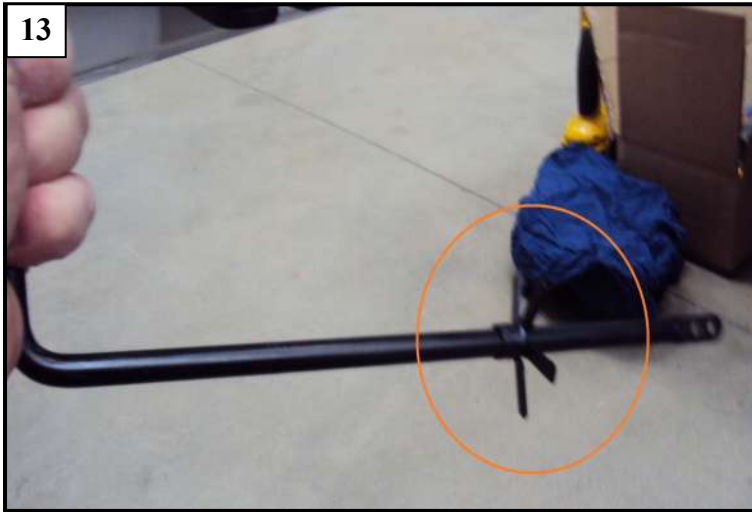



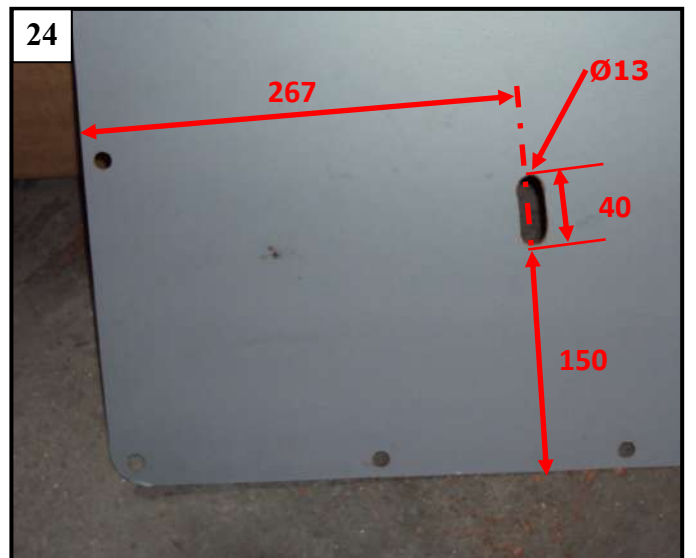
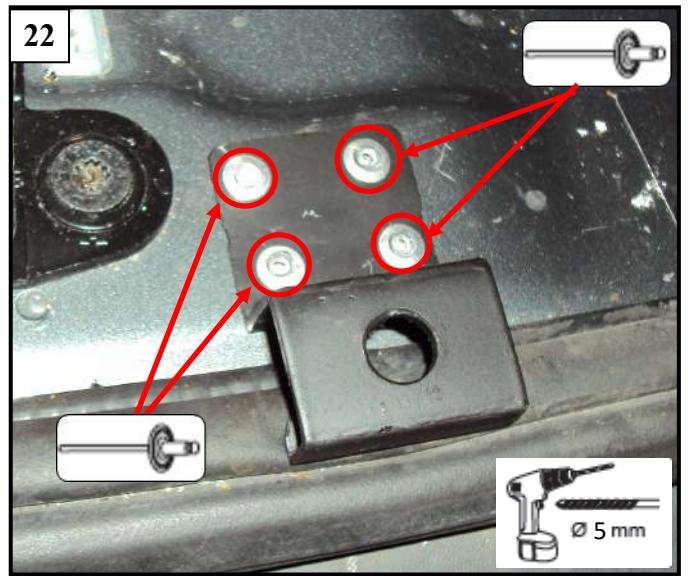
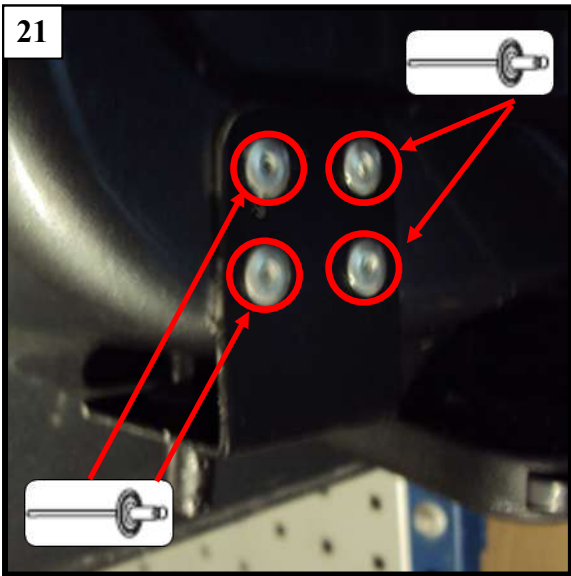
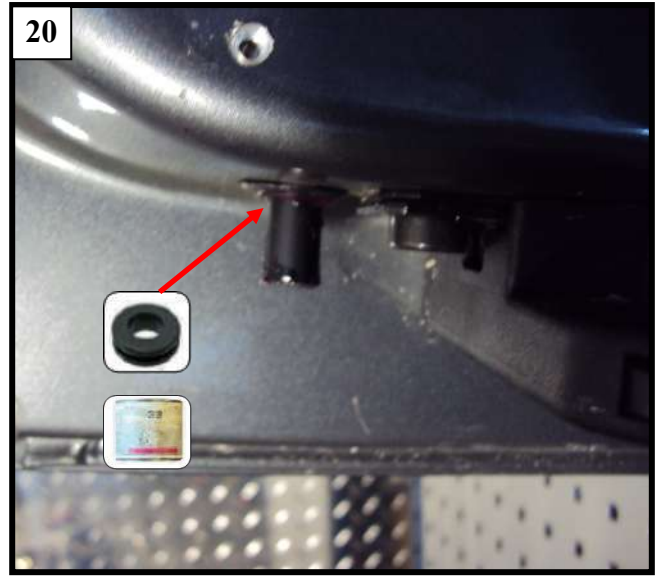
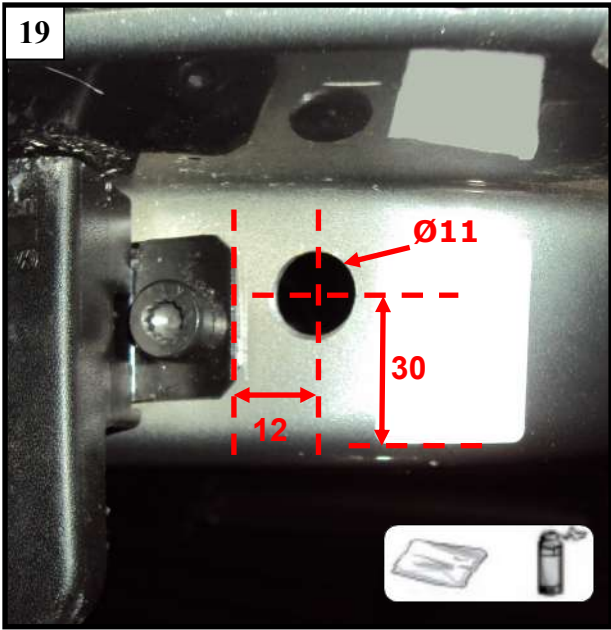

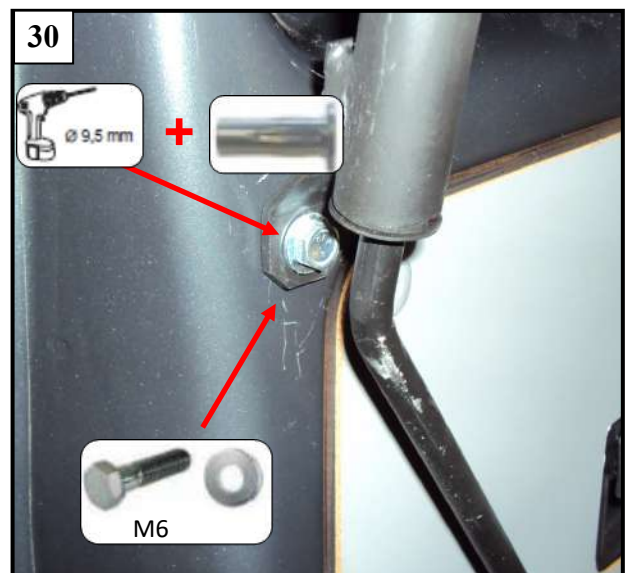
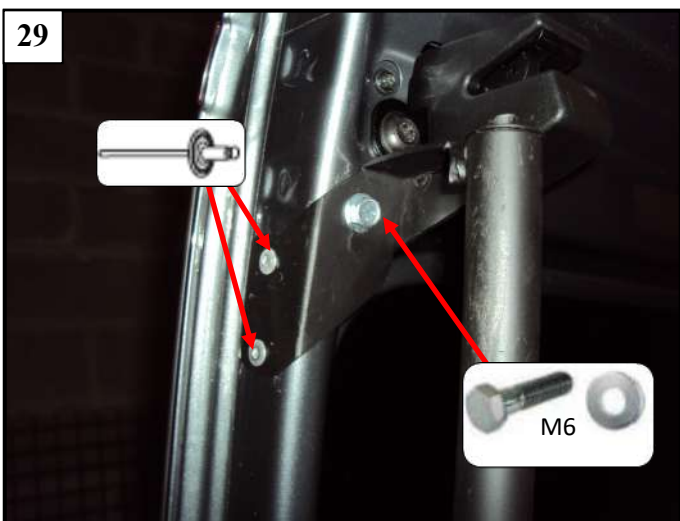
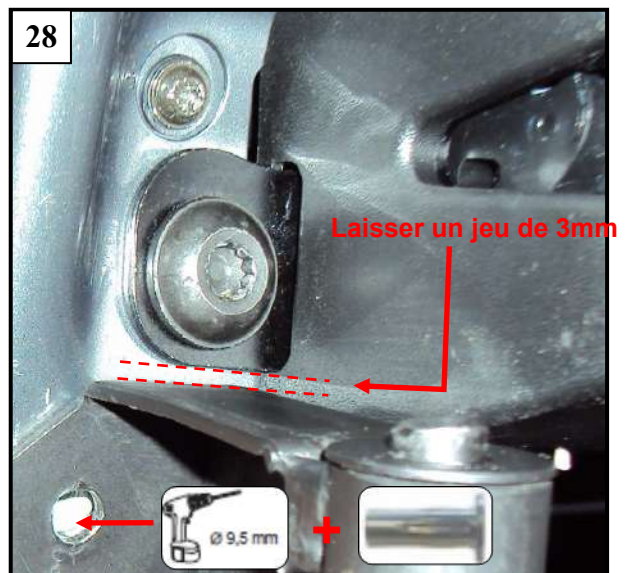
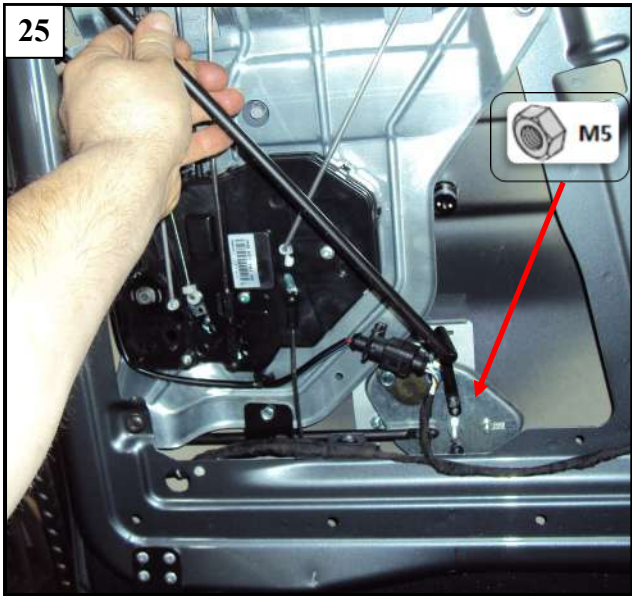



31

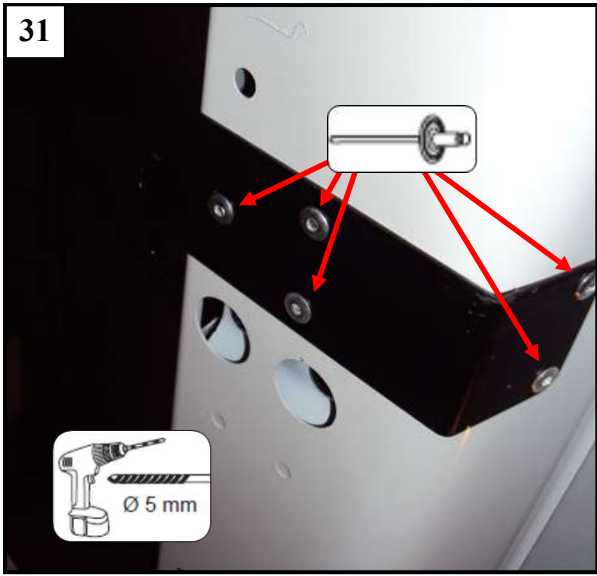

32





## GABARIT DE PERCAGE - SERRURE MUL-T-LOCK

- 1- Imprimer le Gabarit et vérifier l'échelle avant de l'utiliser;
- 2- Découper le contour de la zone grise comme indiqué;
- 3- Positionner le gabarit selon les indications de la notice;
- 4- Repérer les points de perçage;
- 5- Effectuer le perçage.

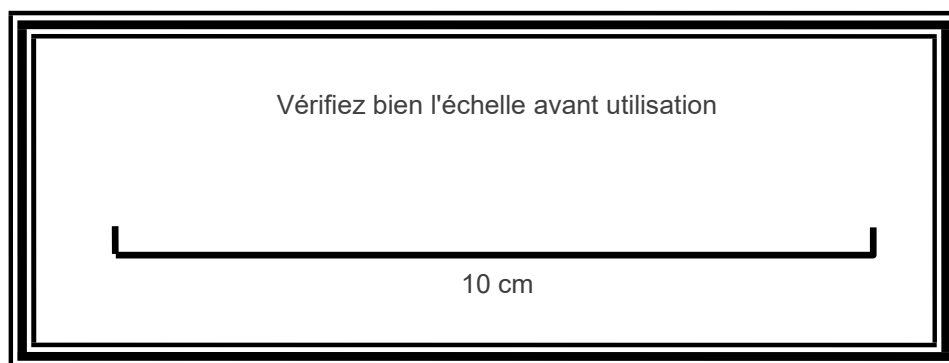
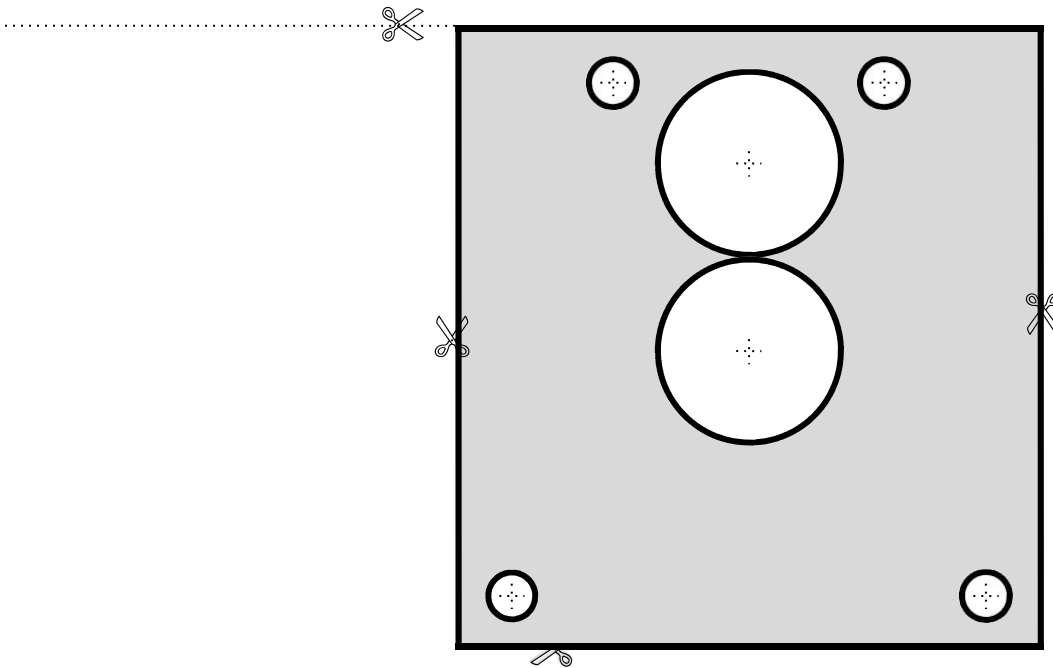





**DIVISION AUTOMOBILE MUL-T-LOCK**

**4 AVENUE D'OUessant - BÂT E**

**92140 VILLEBON-SUR-YVETTE**

**Tél : 01 41 28 39 70**

**Fax : 01 69 53 01 85**

**[www.mul-t-lock.com](http://www.mul-t-lock.com)**

**Support commercial**

**01 41 28 39 70**

**[adv@mul-t-lock.fr](mailto:adv@mul-t-lock.fr)**

**Support technique**

**06 62 91 58 58**

**[automobile@mul-t-lock.fr](mailto:automobile@mul-t-lock.fr)**

